

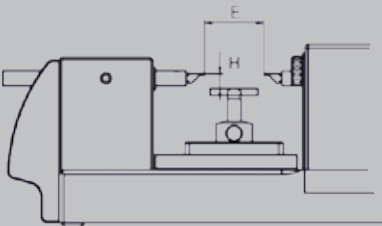

**Zubehör Auflagetische**  
PS 16 V2

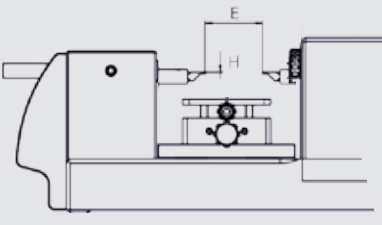

Bestell-Nr	Bezeichnung	PS 16 V2	PS 16 V2 LV	PS 16 V2 3-Punkt	PS 16 V2 Goutte
1362-1035	Auflagetisch einstellbar XYZ				
		✓			
1362-1068	Auflagetisch mit Feineinstellung XZ				
		✓			



Messuhr optional



Zubehör - Sonstiges  
PS 15, PS 16 und PS 17

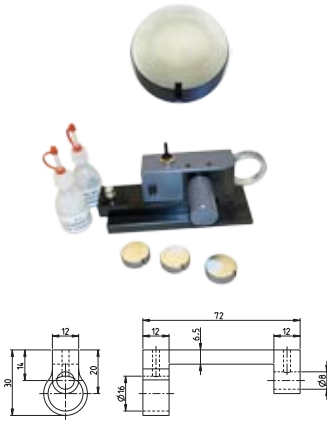

Bestell-Nr	Bezeichnung	PS 15 BH	PS 15 BV	PS 15 BV+	PS 16 V2	PS 16 V2 LV	PS 16 V2 3-Punkte	PS 16 V2 Goutte	PS 17 VS /VP/EP
1362-1044	Ersatz-Läppstein für Läpp-System (1362-1045)	✓			✓				✓
1362-1045	Läpp-System (3 Steine + Läppflüssigkeit inklusive)	✓			✓				✓
1362-1039	Messuhrenhalter (Anzeige der Höhe / Tiefe)					✓			

Zubehör - Sonder-Tastspitzen  
PS 16

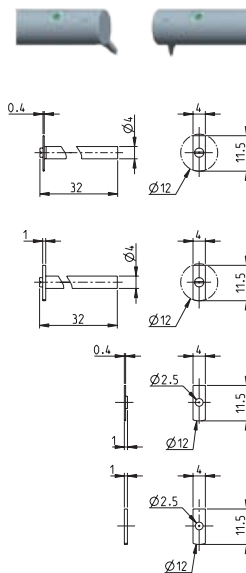

Bestell-Nr	Bezeichnung	PS 15 BH	PS 15 BV	PS 15 BV+	PS 16 V2	PS 16 V2 LV	PS 16 V2 3-Punkte	PS 16 V2 Goutte	PS 17 VS/VP
1362-1066	Tastspitze "Goutte"					✓		✓	
1362-1029	Tastscheibe 0,4 mm aus Stahl inkl. Aufnahmeachse, H: 0 – 20 mm Messbereich 24–27 mm, Messweg 0–48 mm					✓		✓	
1362-1030	Tastscheibe 1 mm aus Stahl inkl. Aufnahmeachse, H: 0 – 20 mm Messbereich 24–27 mm, Messweg 0–48 mm					✓		✓	
1362-1032	Tastscheibe 1 mm aus Stahl					✓		✓	
1362-1031	Tastscheibe 0,4 mm aus Stahl					✓		✓	

**Zubehör Tastspitzen Typ Sylvac  
Aufnahme Ø 1.5 mm**

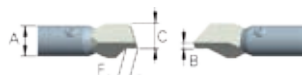

Bestell-Nr	Bezeichnung					PS 15 BH	PS 15 BV	PS 15 BV+	PS 16 V2	PS 16 V2 LV	PS 16 V2 3-Punkte	PS 16 V2 Goutte	PS 17 VS/VP
		B mm	F mm	A mm	C mm								
1362-1024	Messerförmige Tastspitzen HM 0.10 mm	0.10	2.2	Ø 5	4	✓		✓	✓				✓
1362-1041	Messerförmige Tastspitzen HM 0.14 mm	0.14	2.2	Ø 5	4	✓		✓	✓				✓
1362-1022	Messerförmige Tastspitzen HM 0.20 mm	0.20	2.2	Ø 5	4	✓		✓	✓				✓
1362-1020	Messerförmige Tastspitzen HM 0.30 mm	0.30	2.2	Ø 5	4	✓		✓	✓				✓
1362-1017	Messerförmige Tastspitzen HM 0.40 mm	0.40	2.2	Ø 5	4	✓		✓	✓				✓
1362-1011	Messerförmige Tastspitzen HM 0.70 mm	0.70	2.2	Ø 5	4	✓		✓	✓				✓
1362-1026	Messerförmige Tastspitzen HM 0.70 mm /V	0.70	2.2	Ø 5	4	✓		✓	✓				✓
1362-1014	Zylindrische Tastspitzen HM Ø 1.5 mm	-	8	Ø 5	1.5	✓		✓	✓				✓
1362-1015	Zylindrische Tastspitzen HM Ø 2.0 mm	-	8	Ø 5	2.0	✓		✓	✓				✓
1362-1016	Zylindrische Tastspitzen HM Ø 6.5 mm	-	2	Ø 5	6.5	✓		✓	✓				✓
1362-1063	Abgeschrägte Tastspitzen HM 1.5 mm	1.50	2.2	Ø 5	4	✓		✓	✓				✓

**Sonderausführungen auf Anfrage.**

H: Höhe der Tastspitze in Abhängigkeit von der Verstellung des Tisches

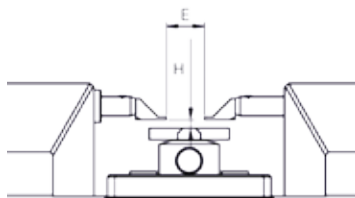

PS 15 - Auflagetisch XYZ  
1362-1005  
E: Messweg 10 mm

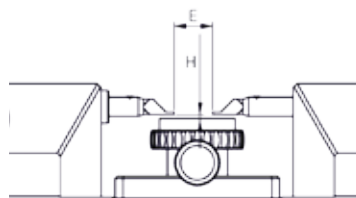

PS 15 - Auflagetisch XYZ  
mit Feineinstellung  
1372-1110  
E: Messweg 10 mm

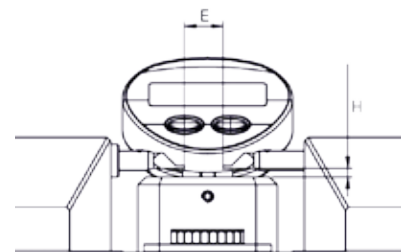

PS 15 - Auflagetisch Z  
1372-1113  
E: Messweg 10 mm

Höhe H1 / H2 (mm) - abhängig von der Ausrichtung der Tastspitzen



PS 15		PS 16		PS 17		
Auflagetisch XYZ 1362-1005	Auflagetisch XYZ 1372-1110	Auflagetisch Z 1372-1113	Auflagetisch XYZ 1362-1035	Auflagetisch XZ 1362-1068	Auflagetisch XYZ 1372-1133	Auflagetisch XZ 1372-1134
0-7.4/0-3.5	0-4.4/0-0.7	0-5.8/0-1.9	0-20.4/0-21.1	0-5.0/0-1.2	0-8.5/0-4.6	0-8.5/0-4.6
0-7.4/0-3.5	0-4.4/0-0.7	0-5.8/0-1.9	0-20.4/0-21.1	0-5.0/0-1.2	0-8.5/0-4.6	0-8.5/0-4.6
0-7.3/0-3.5	0-4.3/0-0.7	0-5.7/0-1.9	0-20.3/0-21.1	0-4.9/0-1.2	0-8.4/0-4.6	0-8.4/0-4.6
0-7.2/0-3.5	0-4.2/0-0.7	0-5.6/0-1.9	0-20.2/0-21.1	0-4.8/0-1.2	0-8.3/0-4.6	0-8.3/0-4.6
0-7.1/0-3.5	0-4.1/0-0.7	0-5.5/0-1.9	0-20.1/0-21.1	0-4.7/0-1.2	0-8.2/0-4.6	0-8.2/0-4.6
0-6.8/0-3.5	0-4.0/0-0.7	0-5.2/0-1.9	0-19.8/0-21.1	0-4.4/0-1.2	0-7.9/0-4.6	0-7.9/0-4.6
0-6.8/--	0-4.0/--	0-5.2/--	0-19.8/--	0-4.4/--	0-7.9/--	0-7.9/--
0-4.6/--	0-1.8/--	0-3.0/--	0-17.8/--	0-2.4/--	--/--	--/--
0-4.4/--	0-1.6/--	0-2.8/--	0-17.6/--	0-2.2/--	--/--	--/--
--	--	--	0-15.3/--	--/--	--/--	--/--
0-6.0/0-3.5	0-3.2/0-0.7	0-4.4/0-1.9	0-19.0/0-21.1	0-3.6/0-1.2	0-7.1/0-4.6	0-7.1/0-4.6

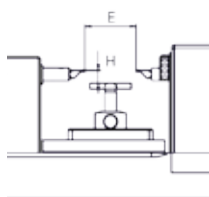

PS 16 - Auflagetisch XYZ verstellbar  
1362-1035

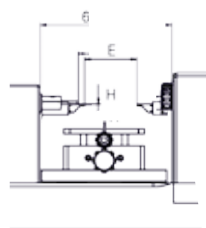

PS 16 - Auflagetisch XZ einstellbar  
1362-1068

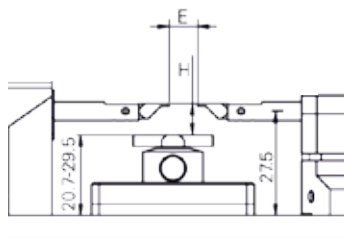

PS 17 - Auflagetisch XYZ  
1372-1133  
E: Messweg 10 mm  
E: Messbereich 19.5 mm (Anschlag verschieben)

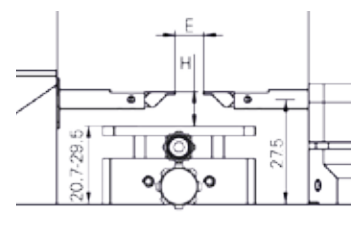

PS 17 - Auflagetisch XZ  
1372-1134  
E: Messweg 10 mm  
E: Messbereich 19.5 mm (Anschlag verschieben)

**Zubehör Tastspitzen Typ Cary kompatibel, M2.5**



Bestell-Nr	Bezeichnung					PS 15 BH	PS 15 BV	PS 15 BV+	PS 16 V2	PS 16 V2 LV	PS 16 V2 3-Punkte	PS 16 V2 Goutte	PS 17 VS/VP
		B mm	F mm	A mm	C mm								
1372-1024	Messerförmige Tastspitzen HM 0.10 mm	0.10	2.2	∅ 5	4	✓	✓	✓	✓				✓
1372-1017	Messerförmige Tastspitzen HM 0.12 mm	0.12	2.2	∅ 5	4	✓	✓	✓	✓				✓
1372-1018	Messerförmige Tastspitzen HM 0.14 mm	0.14	2.2	∅ 5	4	✓	✓	✓	✓				✓
1372-1019	Messerförmige Tastspitzen HM 0.15 mm	0.15	2.2	∅ 5	4	✓	✓	✓	✓				✓
1372-1022	Messerförmige Tastspitzen HM 0.20 mm	0.20	2.2	∅ 5	4	✓	✓	✓	✓				✓
1372-1026	Messerförmige Tastspitzen HM 0.30 mm	0.30	2.2	∅ 5	4	✓	✓	✓	✓				✓
1372-1030	Messerförmige Tastspitzen HM 0.40 mm	0.40	2.2	∅ 5	4	✓	✓	✓	✓				✓
1372-1034	Messerförmige Tastspitzen HM 0.70 mm	0.70	2.2	∅ 5	4	✓	✓	✓	✓				✓
1372-1038	Messerförmige Tastspitzen HM 0.70 mm /V	0.70	2.2	∅ 5	4	✓	✓	✓	✓				✓
1372-1050	Zylindrische Tastspitzen HM ∅ 1.5 mm	-	6	∅ 5	1.5	✓	✓	✓	✓				✓
1372-1054	Zylindrische Tastspitzen HM ∅ 2.0 mm	-	6	∅ 5	2.0	✓	✓	✓	✓				✓
1372-1058	Zylindrische Tastspitzen HM ∅ 3 mm	-	6	∅ 5	3.0	✓	✓	✓	✓				✓
1372-1046	Abgeschrägte Tastspitzen HM 1.5 mm	1.50	2.2	∅ 5	4	✓	✓	✓	✓				✓

**Sonderausführungen auf Anfrage.**

H: Höhe der Tastspitze in Abhängigkeit von der Verstellung des Tisches

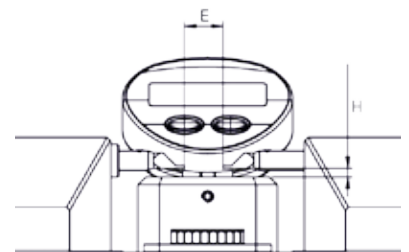
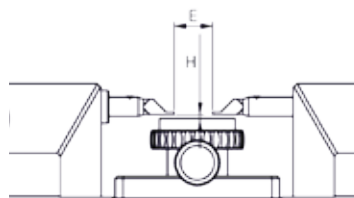
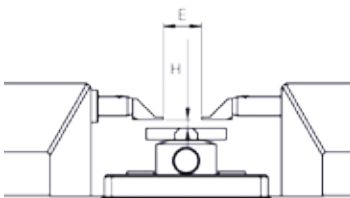

PS 15 - Auflagetisch XYZ  
1362-1005  
E: Messweg 10 mm

PS 15 - Auflagetisch XYZ  
mit Feineinstellung  
1372-1110  
E: Messweg 10 mm

PS 15 - Auflagetisch Z  
1372-1113  
E: Messweg 10 mm

Höhe H1 / H2 (mm) - abhängig von der Ausrichtung der Tastspitzen



PS 15		PS 16		PS 17		
Auflagetisch XYZ 1362-1005	Auflagetisch XYZ 1372-1110	Auflagetisch Z 1372-1113	Auflagetisch XYZ 1362-1035	Auflagetisch XZ 1362-1068	Auflagetisch XYZ 1372-1133	Auflagetisch XZ 1372-1134
0-9,1/0-7.2	0-6.3/0-4.4	0-7.5/0-5.6	0-23.1/0-21.1	0-7.6/0-5.7	0-10.2/0-8.3	0-10.2/0-8.3
0-9,1/0-7.2	0-6.3/0-4.4	0-7.5/0-5.6	0-23.1/0-21.1	0-7.6/0-5.7	0-10.2/0-8.3	0-10.2/0-8.3
0-9,1/0-7.2	0-6.2/0-4.4	0-7.5/0-5.6	0-23.1/0-21.1	0-7.6/0-5.7	0-10.2/0-8.3	0-10.2/0-8.3
0-9.0/0-7.2	0-6.2/0-4.4	0-7.4/0-5.6	0-23.0/0-21.1	0-7.5/0-5.7	0-10.1/0-8.3	0-10.1/0-8.3
0-9.0/0-7.2	0-6.2/0-4.4	0-7.4/0-5.6	0-23.0/0-21.1	0-7.5/0-5.7	0-10.1/0-8.3	0-10.1/0-8.3
0-8.9/0-7.2	0-6.1/0-4.4	0-7.3/0-5.6	0-22.9/0-21.1	0-7.4/0-5.7	0-10.0/0-8.3	0-10.020/0-8.3
0-8.8/0-7.2	0-6.0/0-4.4	0-7.2/0-5.6	0-22.8/0-21.1	0-7.3/0-5.7	0-9.9/0-8.3	0-9.9/0-8.3
0-8.5/0-7.2	0-5.7/0-4.4	0-6.9/0-5.6	0-22.5/0-21.1	0-7.0/0-5.7	0-9.6/0-8.3	0-9.6/0-8.3
0-9.2/--	0-6.4/--	0-7.6/--	0-23.7/--	0-7.7/--	0-10.3/--	0-10.3/--
0-7.4/--	0-4.6/--	0-5.8/--	0-21.4/--	0-5.9/--	0-8.5/--	0-8.5/--
0-7.2/--	0-4.4/--	0-5.6/--	0-21.2/--	0-5.7/--	0-8.3/--	0-8.3/--
0-6.7/--	0-3.9/--	0-5.1/--	0-20.7/--	0-5.2/--	0-7.8/--	0-7.8/--
0-7.7/0-7.2	0-4.9/0-4.4	0-6.1/0-5.6	0-21.7/0-21.1	0-6.2/0-5.7	0-8.8/0-8.3	0-8.8/0-8.3

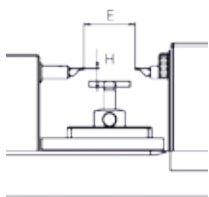

PS 16 - Auflagetisch XYZ  
verstellbar  
1362-1035

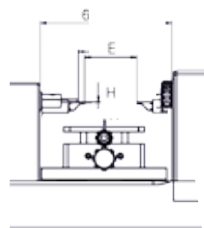

PS 16 - Auflagetisch XZ  
einstellbar  
1362-1068

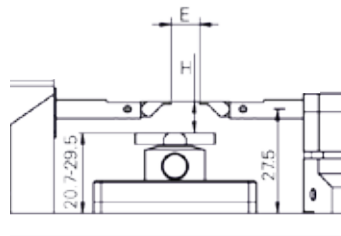

PS 17 - Auflagetisch XYZ  
1372-1133  
E: Messweg 10 mm  
E: Messbereich 19.5 mm  
(Anschlag verschieben)

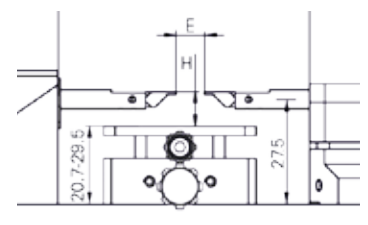

PS 17 - Auflagetisch XZ  
1372-1134  
E: Messweg 10 mm  
E: Messbereich 19.5 mm  
(Anschlag verschieben)